

Instructions for Use
Xolair® (ZOHL-air)
(omalizumab)
injection, for subcutaneous use
Prefilled Syringe

Read this Instructions for Use before you start using the XOLAIR prefilled syringe and each time you get a refill. Before you use the XOLAIR prefilled syringe for the first time, make sure your healthcare provider shows you the right way to use it. Contact your healthcare provider if you have any questions.

Do not use XOLAIR for the emergency treatment of any allergic reactions, including anaphylaxis, hives, or sudden breathing problems.

Prefilled Syringe Parts

Before use:

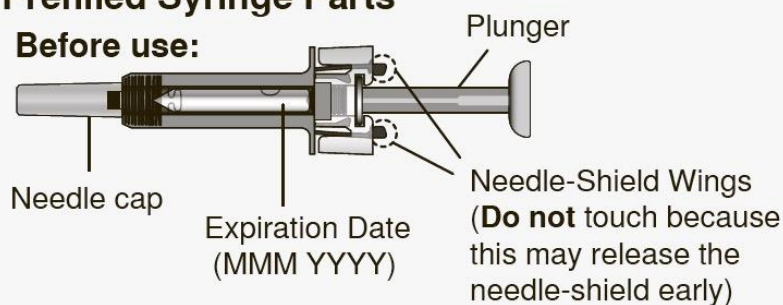

After use:

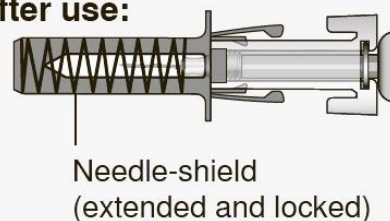

Supplies needed to give your injection

- XOLAIR prefilled syringes (You may need more than 1 prefilled syringe for your prescribed dose). See **“Choose the correct prefilled syringe or combination of prefilled syringes”** for more information. Each XOLAIR carton contains 1 prefilled syringe.

The following supplies are not included in the carton:

- Alcohol swab
- Sterile cotton ball or gauze

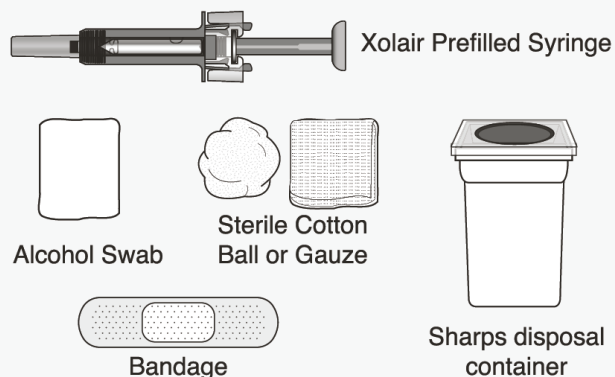









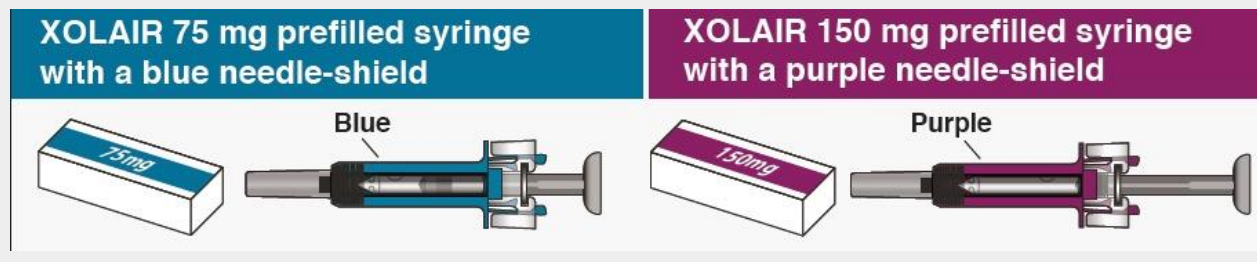



- Small bandage
- Sharps disposal container (see **step 14 “After the Injection”**)

Choose the correct prefilled syringe or combination of prefilled syringes

XOLAIR prefilled syringes are available in 2 dose strengths. These instructions are to be used for both dose strengths.

Your prescribed dose may require more than 1 injection. The table below shows the combination of prefilled syringes needed to give your full dose. Check the label on the XOLAIR carton to make sure you have received the correct prefilled syringe or combination of prefilled syringes for your prescribed dose. If your dose requires more than 1 injection, inject the medicine from all of your prescribed prefilled syringes, immediately one after another. Contact your healthcare provider if you have any questions.



Dose	Syringes needed for the dose	75 mg	150 mg
75 mg	1 blue (75 mg)		
150 mg	1 purple (150 mg)		
225 mg	1 blue (75 mg) + 1 purple (150 mg)		
300 mg	2 purple (150 mg)		
375 mg	1 blue (75 mg) + 2 purple (150 mg)		
450 mg	3 purple (150 mg)		
525 mg	1 blue (75 mg) + 3 purple (150 mg)		
600 mg	4 purple (150 mg)		

How should I store XOLAIR?

- Keep your unused prefilled syringes in the original carton and store the carton in a refrigerator between 36°F to 46°F (2°C to 8°C). **Do not** remove the prefilled syringe from its original carton during storage.
- Before giving an injection, the carton can be removed from and placed back in the refrigerator if needed. The total combined time out of the refrigerator may not exceed 2 days. If the prefilled syringe is exposed to temperatures above 77 °F (25 °C), **do not** use it and throw away in a sharps disposal container.
- Keep your XOLAIR prefilled syringes out of direct sunlight.
- **Do not** freeze. Do not use if the prefilled syringe has been frozen.

Keep the XOLAIR prefilled syringe, sharps disposal container and all medicines out of the reach of children.

Important Information

- The needle cap contains a type of natural rubber latex. Tell your healthcare provider if you have a latex allergy.
- **Do not** open the sealed carton until you are ready to inject XOLAIR.
- **Do not** take the needle cap off until you are ready to inject XOLAIR.
- **Do not** try to take the prefilled syringe apart at any time.
- **Do not** reuse the same prefilled syringe.
- **Do not** leave the prefilled syringe unattended.

Preparing for the Injection

1 Take the carton containing the prefilled syringe out of the refrigerator.

- If your dose requires you to give more than 1 injection, take all cartons out of the refrigerator at the same time. The following steps must be followed for **each** prefilled syringe.

2 Check the expiration date on the XOLAIR carton.

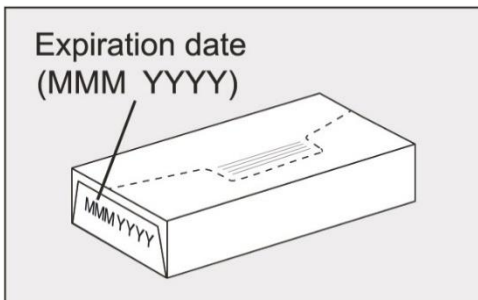

- **Do not** use if the expiration date has passed.
If the expiration date has passed, safely throw away the prefilled syringe in a sharps disposal container (see **step 14**) and contact your healthcare provider.

3 Place the carton on a clean, flat surface.

- Set aside the carton for at least 15 to 30 minutes so the prefilled syringe can warm up on its own to room temperature. Leave the prefilled syringe in the carton to protect it from light.
- If the prefilled syringe does not reach room temperature, this could cause the injection to feel uncomfortable and make it hard to push the plunger.
- **Do not** speed up the warming process using any heat sources such as warm water or a microwave.

Preparing for the Injection

4 Open the carton.

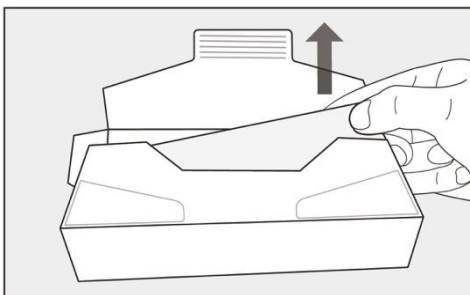

- Wash your hands with soap and water.
- Take the blister pack out of the carton.

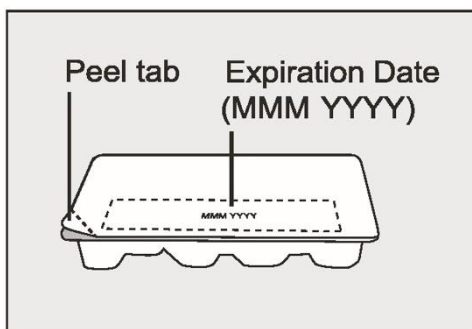

- Check the expiration date on the blister pack.
- **Do not** use it if the expiration date has passed.

If the expiration date has passed, safely throw away the prefilled syringe in a sharps disposal container (see **step 14**) and contact your healthcare provider.

- Peel off the blister pack cover fully. Be careful when taking out the prefilled syringe.
- **Do not** flip the blister pack upside down to take out the prefilled syringe. This may damage the prefilled syringe.
- Take the prefilled syringe out of the blister pack by holding the middle part of the prefilled syringe. When holding the prefilled syringe, make sure you always hold the prefilled syringe as shown. **Do not** touch the needle-shield wings (see "**Prefilled Syringe Parts**").
- **Do not** handle the prefilled syringe by holding the plunger or needle cap.

Preparing for the Injection

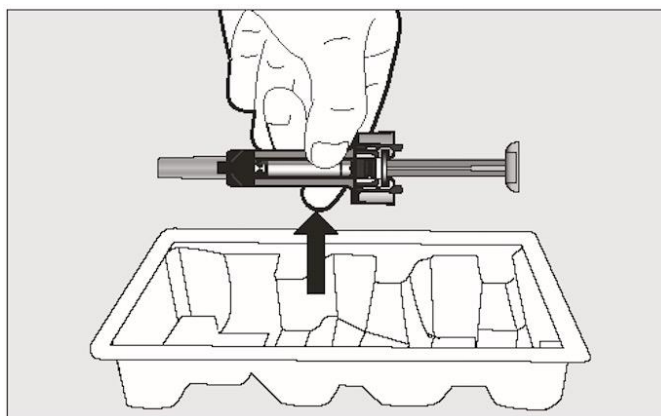

5 Inspect the prefilled syringe closely.

- Check the prefilled syringe. The medicine in the prefilled syringe should be clear and colorless to pale brownish-yellow. **Do not** use the prefilled syringe if the medicine is cloudy, discolored, or contains particles.
- Check the expiration date on the prefilled syringe. **Do not** use the prefilled syringe if the expiration date has passed.
- If the medicine does not look as described or if the expiration date has passed, safely throw away the prefilled syringe in a sharps disposal container (see **step 14**) and contact your healthcare provider.
- **Do not** use if the packaging or prefilled syringe appears damaged, tampered with, or has been dropped.

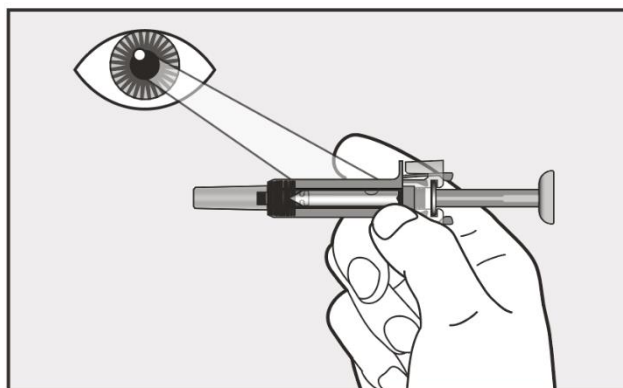

Preparing for the Injection

6 Choose an injection site.

- If you are giving yourself the injection, you can inject into the front and middle of the thighs and the stomach area (abdomen). The outer area of the upper arms may also be used if the injection is being given by a caregiver. **Do not** try to inject into the upper arm area by yourself.
- **Do not** inject within the 2-inch area directly around your belly button (navel).
- **Do not** inject into moles, scars, bruises, or areas where the skin is tender, red, hard, or if there are breaks in the skin.
- **Do not** inject through clothing. The injection site should be exposed, clean skin.
- If your prescribed dose requires more than 1 injection, choose a different injection site for each new injection, at least 1 inch from other injection sites.

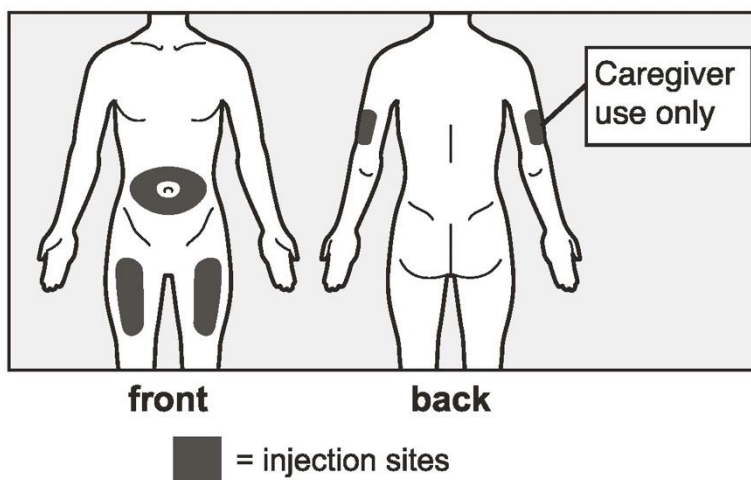

Preparing for the Injection

7 Wipe the injection site with an alcohol swab in a circular motion and let it air dry for 10 seconds.

- **Do not** touch the injection site again before giving the injection.
- **Do not** fan or blow on the cleaned skin.

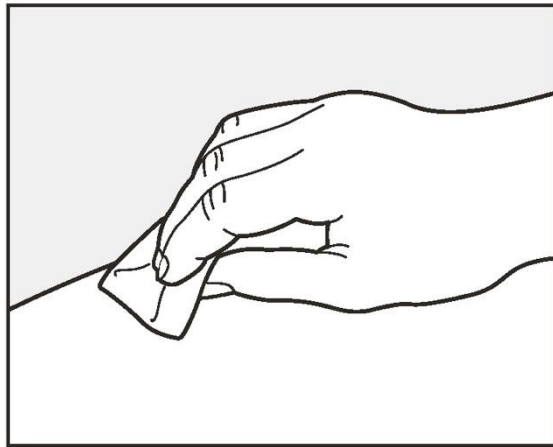

Giving the Injection

8 Hold the prefilled syringe firmly by the center with 1 hand and pull the needle cap straight off with your other hand.

- **Do not** twist the needle cap.
- **Do not** hold, push or pull the plunger while you remove the needle cap.
- **Do not** touch the needle or let it touch any surfaces after removing the needle cap.
- Throw away the needle cap in regular household trash. **Do not** recap the needle.
- There may be 1 or more small air bubbles in the prefilled syringe. This is normal, and you should not try to remove the air bubbles.
- You may also see a drop of liquid at the end of the needle. This is also normal and will not affect the dose.

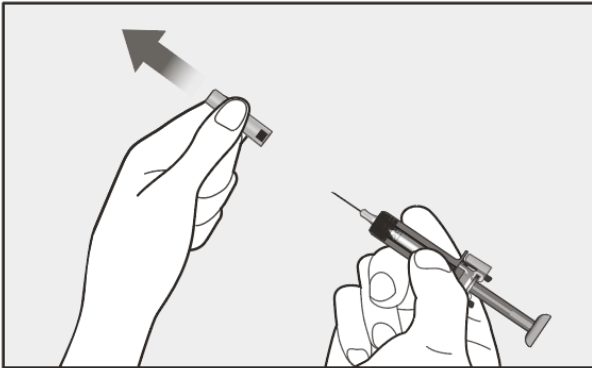

9 Use your other hand and gently pinch the area of skin that was cleaned. Hold the pinched skin tight.

- Pinching the skin is important to make sure that you inject under the skin (into the fatty area) but not any deeper (into muscle).

Giving the Injection

10 Continue holding the prefilled syringe by the center and use a quick, dart-like motion to insert the needle all the way into the pinched skin at an angle between 45 degrees to 90 degrees as shown.

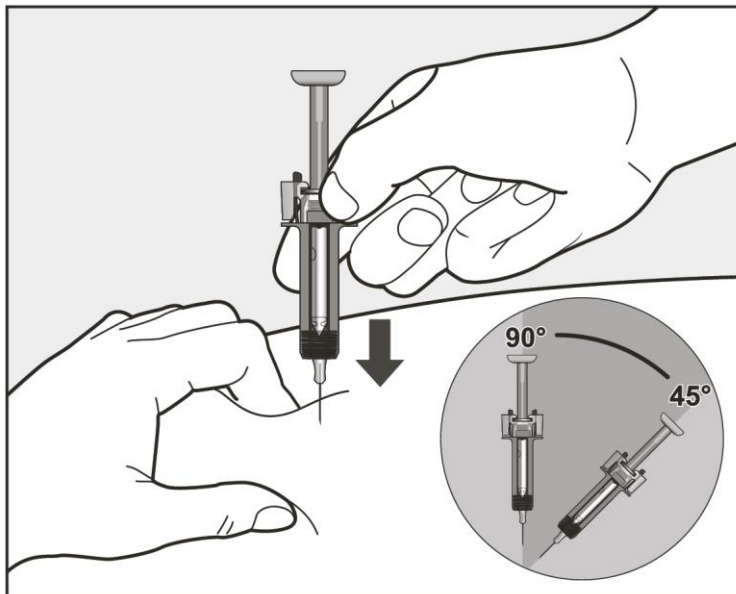

- It is important to use the correct angle to make sure the medicine is delivered under the skin (into the fatty area), or the injection could be uncomfortable and the medicine may not work.
- **Do not** touch the plunger while inserting the needle into the skin.
- **Do not** insert the needle through clothing.
- Hold the prefilled syringe tightly in place and **do not** change the angle of injection or insert the needle again after the needle is inserted.
- You should not move and should avoid sudden movements when giving the injection.

11 Slowly inject all of the medicine by gently pushing the plunger all the way down until the needle-shield wings are pushed apart.

- You must press the plunger all the way down to make sure that the full dose of medicine gets injected. If the plunger is not fully pressed, the needle-shield will not extend to cover the needle when it is removed.

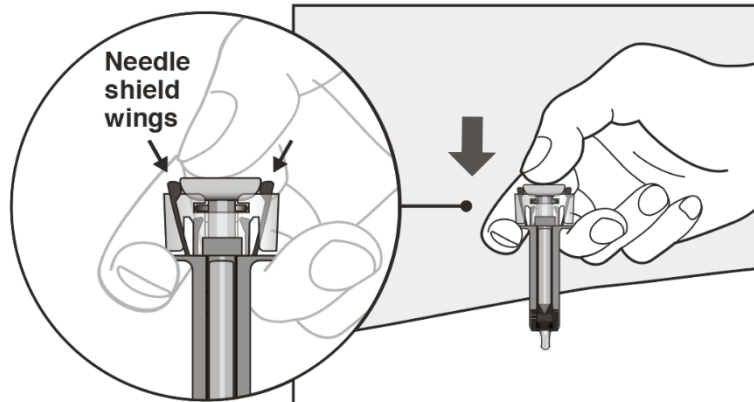

12 Release the plunger and allow the needle to be covered by the needle-shield.

- If the needle is not covered by the needle-shield, carefully remove the prefilled syringe from the skin and throw away the prefilled syringe in a sharps disposal container (see **step 14**).

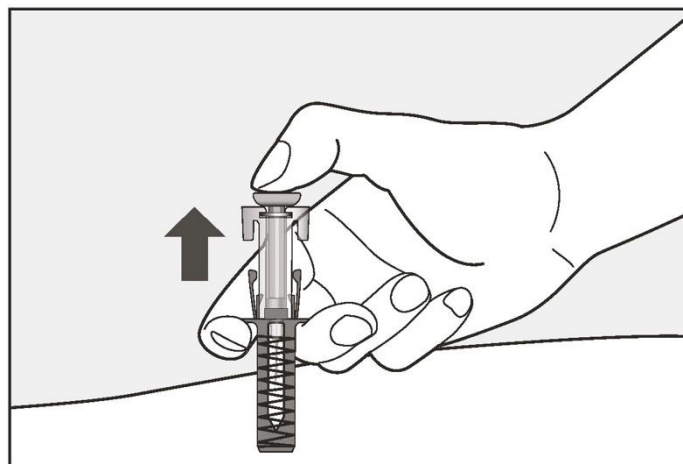

Giving the Injection

13 There may be a little bleeding at the injection site. You can press a cotton ball or gauze over the injection site.

- **Do not** rub the injection site.
- If needed, cover the injection site with a small bandage.
- In case of skin contact with the medicine, wash the area that touched the medicine with water.

If your prescribed dose requires more than 1 injection:

- Throw away the used prefilled syringe as described in **step 14**.
- Repeat **step 2** through **step 13** for the next injection using a new prefilled syringe.
- Choose a different injection site for each new injection at least 1 inch from other injection sites.
- Complete all the required injections for your prescribed dose, immediately one after another. Contact your healthcare provider if you have any questions.

After the Injection

14 **Throw away (dispose of) your used XOLAIR prefilled syringes in an FDA-cleared sharps disposal container right away after use.**

- The XOLAIR prefilled syringe is a single-dose prefilled syringe and should not be used again.
- **Do not** throw away prefilled syringes in your household trash.
- **Do not** recap the needle.

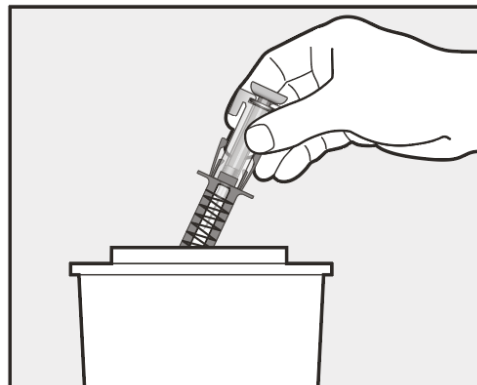

If you do not have an FDA-cleared sharps disposal container, you may use a household container that is:

- made of a heavy-duty plastic,
- can be closed with a tight-fitting, puncture-resistant lid, without sharps being able to come out,
- upright and stable during use,
- leak-resistant, and
- properly labeled to warn of hazardous waste inside the container.
- When your sharps disposal container is almost full, you will need to follow your community guidelines for the right way to dispose of your sharps disposal container. There may be state or local laws about how you should throw away used prefilled syringes. For more information about safe sharps disposal, and for specific information about sharps disposal in the state that you live in, go to the FDA's website at: <http://www.fda.gov/safesharpsdisposal>
- **Do not** dispose of your used sharps disposal container in your household trash unless your community guidelines permit this.
- **Do not** recycle your used sharps disposal container.

Manufactured by:

Genentech, Inc., A Member of the Roche Group,
1 DNA Way, South San Francisco, CA 94080-4990
U.S. License No.: 1048

Jointly marketed by:

Genentech USA, Inc., A Member of the Roche Group,
1 DNA Way, South San Francisco, CA 94080-4990
Novartis Pharmaceuticals Corporation,
One Health Plaza, East Hanover, NJ 07936-1080

XOLAIR® is a registered trademark of Novartis AG.
©2024 Genentech USA, Inc.

Instructions for Use

Xolair® (ZOHL-air)

(omalizumab)

injection, for subcutaneous use

Prefilled Syringe

Read this Instructions for Use before you start using Xolair prefilled syringe and each time you get a refill. Before you use Xolair prefilled syringe for the first time, make sure your healthcare provider shows you the right way to use it. Contact your healthcare provider if you have any questions.

Do not use Xolair for the emergency treatment of any allergic reactions, including anaphylaxis, hives, or sudden breathing problems.

Prefilled Syringe Parts

Before Use

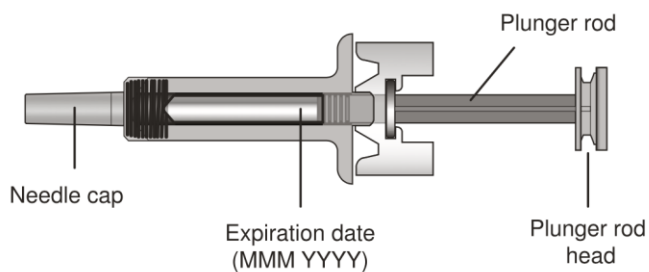

After Use

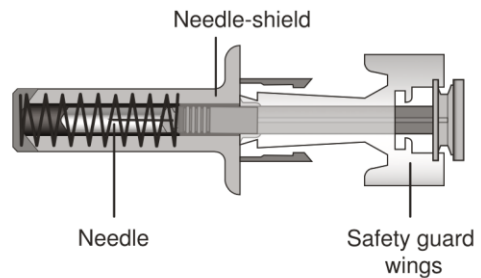

Supplies needed to give your injection

- Xolair prefilled syringe.

The following supplies are not included in the carton:

- Alcohol swab
- Sterile cotton ball or gauze
- Small bandage
- Sharps disposal container (see **Step 14**)

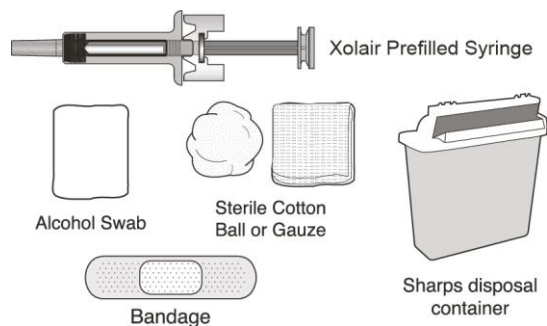











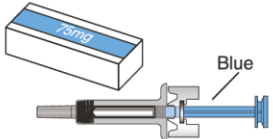
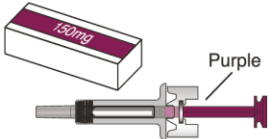
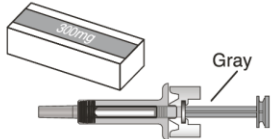



Note: You may need more than 1 Xolair prefilled syringe for your prescribed dose. See the **Dosing Table** for more information. Each Xolair carton contains 1 prefilled syringe.

Choose the correct prefilled syringe or combination of prefilled syringes

Xolair prefilled syringes are available in 3 dose strengths (1 prefilled syringe in each carton). These instructions are to be used for all 3 dose strengths.

Your prescribed dose may require more than 1 injection. The **Dosing Table** below shows the combination of prefilled syringes needed to give your full dose. Check the label on the Xolair carton to make sure you have received the correct prefilled syringe or combination of prefilled syringes for your prescribed dose. If your dose requires more than 1 injection, complete all injections for your prescribed dose, immediately one after another. Contact your healthcare provider if you have any questions.

Dosing Table

Xolair 75 mg prefilled syringe with a blue plunger rod		Xolair 150 mg prefilled syringe with a purple plunger rod		Xolair 300 mg prefilled syringe with a gray plunger rod	
					
Dose	Syringes recommended for dose	75 mg	150 mg	300 mg	
75 mg	1 blue				
150 mg	1 purple				
225 mg	1 blue + 1 purple				
300 mg	1 gray				
375 mg	1 blue + 1 gray				
450 mg	1 purple + 1 gray				
525 mg	1 blue + 1 purple + 1 gray				
600 mg	2 gray				

Note: Your healthcare provider may prescribe a different combination of syringes for your complete dose.

How should I store Xolair?

- Keep your unused prefilled syringes in the original carton and store the carton in a refrigerator between 36°F to 46°F (2°C to 8°C). **Do not** remove the prefilled syringe from its original carton during storage.
- Before giving an injection, the carton can be removed from and placed back in the refrigerator if needed. The total combined time out of the refrigerator may not be more than 2 days. If the prefilled syringe is left at temperatures above 77°F (25°C), **do not** use it and throw away in a sharps disposal container.
- Keep your prefilled syringes out of direct light.
- **Do not** freeze. **Do not** use if the prefilled syringe has been frozen.

Keep the Xolair prefilled syringe, sharps disposal container and all medicines out of the reach of children.

Important Information

- **Do not** use if the carton is damaged or appears to be tampered with.
- **Do not** open the carton until you are ready to inject.
- **Do not** use if the prefilled syringe is damaged or appears to be tampered with.
- **Do not** take the needle cap off until you are ready to inject.
- **Do not** use if the prefilled syringe has been dropped on a hard surface or dropped after removing the needle cap.
- **Do not** try to take apart the prefilled syringe at any time.

Preparing for the Injection

1 Take the carton containing the prefilled syringe out of the refrigerator.

- If you need more than 1 prefilled syringe to deliver your full dose (see **Dosing Table**), take all cartons out of the refrigerator at the same time (each carton contains 1 prefilled syringe). The following steps must be followed for each prefilled syringe.

2 Check the expiration date on the Xolair carton.

- **Do not** use if the expiration date has passed.
- If the expiration date has passed, safely throw away the prefilled syringe in a sharps disposal container (see **Step 14**) and contact your healthcare provider.

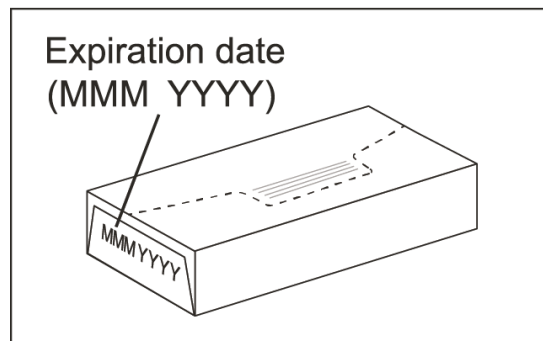

3 Allow the prefilled syringe to reach room temperature.

- Set aside the carton on a clean, flat surface for at least 30 to 45 minutes so the prefilled syringe can warm up on its own to room temperature. Leave the prefilled syringe in the carton to protect it from light.
- If the prefilled syringe does not reach room temperature, this could cause the injection to feel uncomfortable and make it hard to push the plunger.
- **Do not** speed up the warming process using any heat sources such as warm water or a microwave.

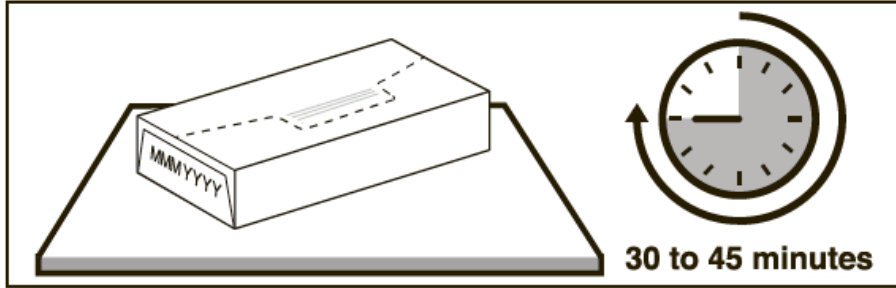

4 Open the carton.

- Wash your hands with soap and water.
- Take the blister pack out of the carton.

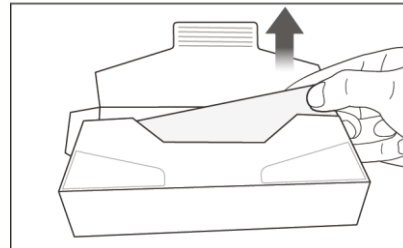

- Check the expiration date on the blister pack.
- **Do not** use it if the expiration date has passed.
If the expiration date has passed, safely throw away the prefilled syringe in a sharps disposal container (see **Step 14**) and contact your healthcare provider.

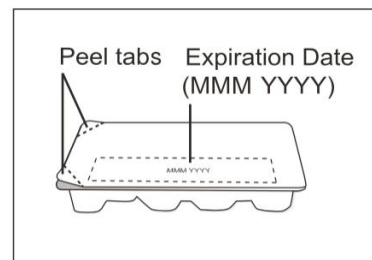

- Peel off the blister pack cover fully. Be careful when taking out the prefilled syringe.
- **Do not** flip the blister pack upside down to take out the prefilled syringe.
- Take the prefilled syringe out of the blister pack by holding the middle part of the prefilled syringe, as shown.
- **Do not** handle the prefilled syringe by holding the plunger or needle cap.

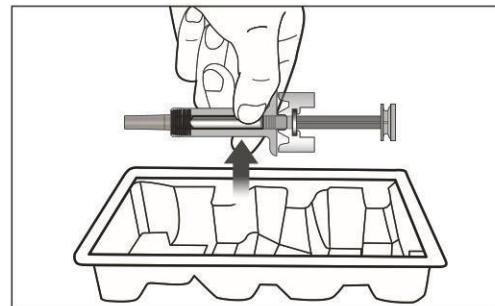

5 Inspect the prefilled syringe closely.

- Check the prefilled syringe. The medicine inside should be clear and colorless to pale brownish-yellow. You may see air bubbles in the medicine, which is normal. **Do not** try to remove the air bubbles.
- **Do not** use the prefilled syringe if the medicine contains particles, or if the medicine looks cloudy or brown.
- Check the expiration date on the prefilled syringe. **Do not** use the prefilled syringe if the expiration date has passed.
- **Do not** use if the prefilled syringe appears to be damaged or tampered with.
- If the medicine does not look as described or if the expiration date has passed, safely throw away the prefilled syringe in a sharps disposal container (see **Step 14**) and contact your healthcare provider.

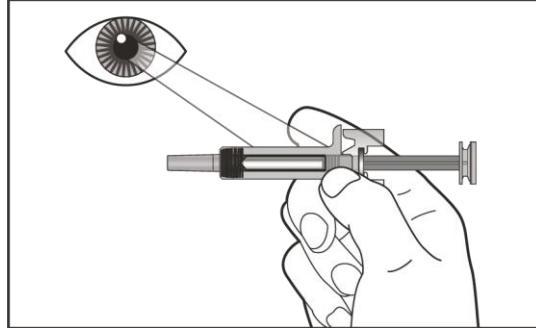

6 Choose where to inject.

- If giving yourself the injection, the injection sites are the front of your thigh or stomach area (abdomen). If a caregiver is giving the injection, the injection sites are the outer area of the upper arm, the front of the thigh, or the stomach area (abdomen). **Do not** try to inject yourself in the upper arm.
- **Do not** inject within the 2-inch area directly around your belly button (navel).
- **Do not** inject into moles, scars, bruises, or areas where the skin is tender, red, hard, or if there are breaks in the skin.
- **Do not** inject through clothing. The injection site should be uncovered, clean skin.
- If your prescribed dose requires more than 1 injection, make sure your injections are **at least 1 inch** apart from each other.

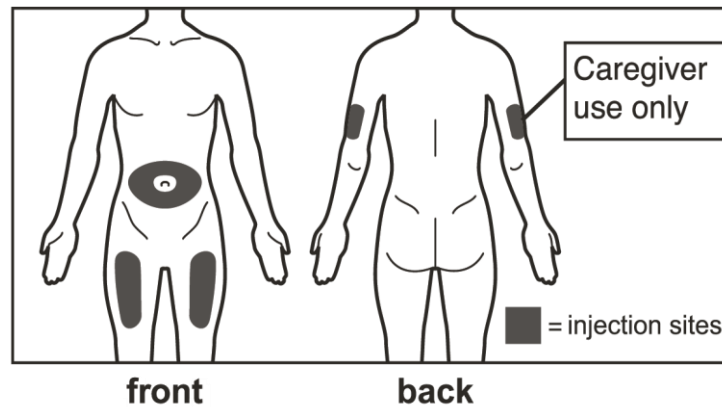

7 Clean the injection site.

- Wipe the injection site with an alcohol swab in a circular motion and let air dry for 10 seconds.
- **Do not** fan or blow on the cleaned skin.
- **Do not** touch the injection site again before giving the injection.

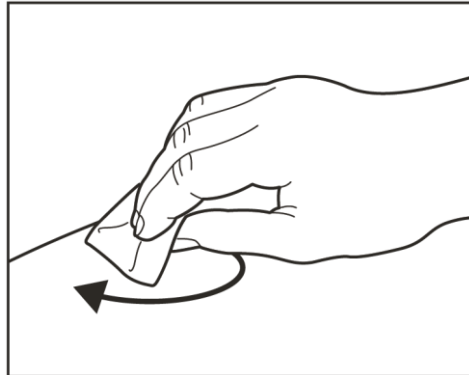

Giving the Injection

8 Remove the cap.

- Hold the prefilled syringe firmly with 1 hand and pull the needle cap straight off with your other hand as shown. **Do not** twist the cap.
- **Do not** hold, push or pull the plunger while you remove the needle cap.
- **Do not** touch the needle or let it touch any surfaces after removing the needle cap.
- **Do not** put the cap back on the prefilled syringe. Throw away the needle cap in regular household trash.
- You may see a drop of liquid at the end of the needle. This is normal.

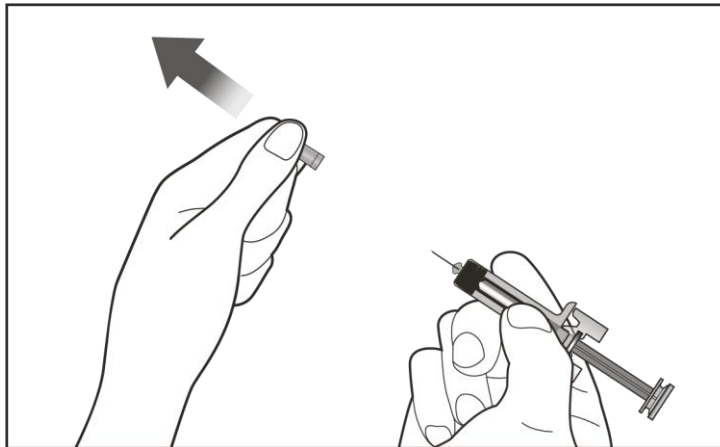

9 Pinch cleaned skin.

- Use your other hand and gently pinch the area of skin that was cleaned. Hold the pinched skin tightly until the injection is complete.
- Pinching the skin is important to make sure that you inject under the skin (into the fatty area) but not any deeper (into muscle).

10 Insert the needle using a quick, dart-like motion.

- While holding the prefilled syringe by the center, insert the needle all the way into the pinched skin at an angle of about 45 degrees as shown.
- It is important to use the correct angle to make sure the medicine is delivered under the skin (into the fatty area), or the injection could be uncomfortable and the medicine may not work.
- **Do not** touch the plunger while inserting the needle into the skin.
- Hold the prefilled syringe tightly in place and **do not** change the angle of injection or insert the needle again after the needle is inserted.
- You should not move and should avoid sudden movements when giving the injection.

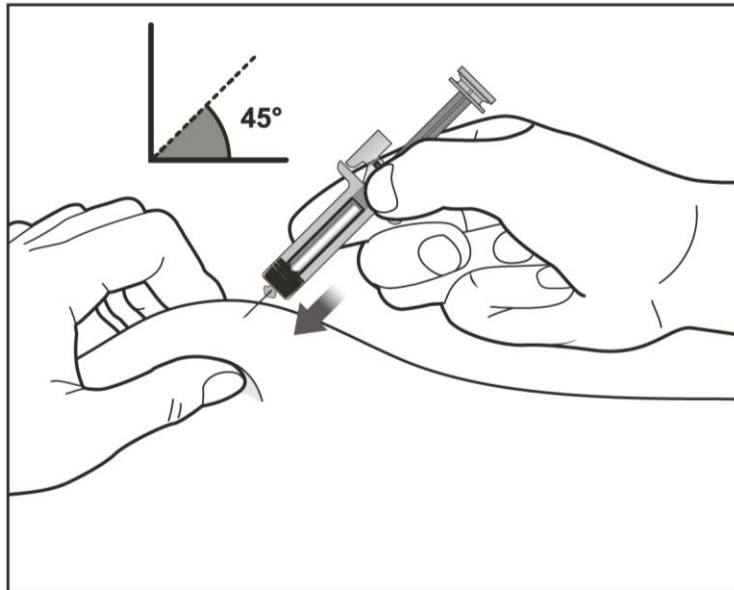

11 Slowly inject all of the medicine.

- Gently push the plunger all the way down until the plunger head is between the safety guard wings as shown.
- You must press the plunger all the way down to make sure that the full dose of medicine is injected. If the plunger is not fully pressed, the needle-shield will not extend to cover the needle when it is removed.

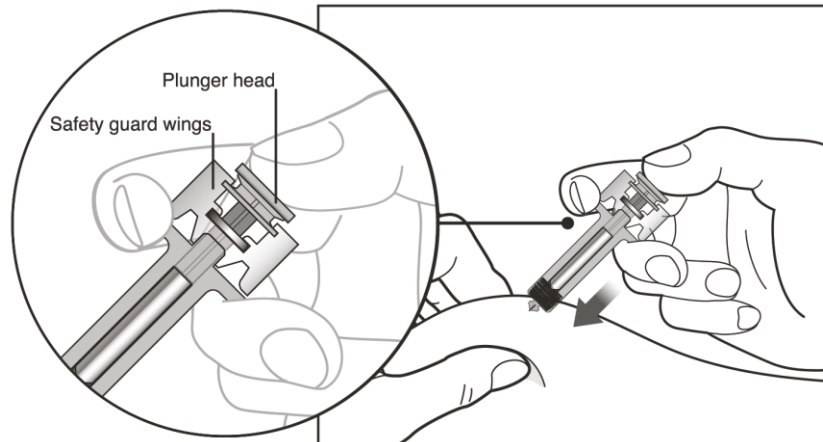

12 Release the plunger.

- Release the plunger and allow the needle to be covered by the needle-shield.
- If the needle is not covered by the needle-shield, carefully remove the prefilled syringe from the skin and throw away the prefilled syringe in a sharps disposal container (see **Step 14**).

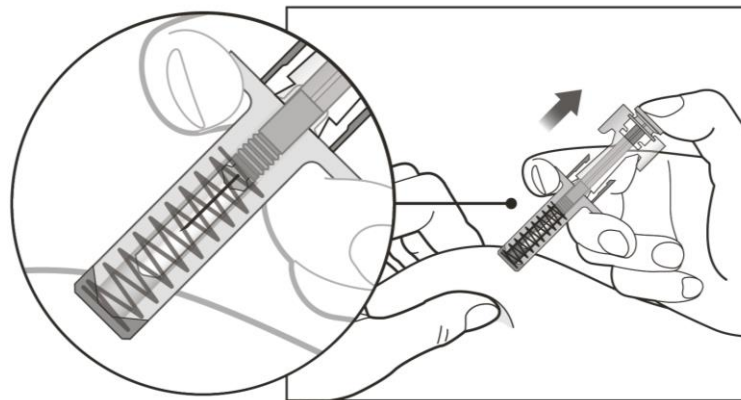

13 Care for the injection site.

- **Do not** rub the injection site.
- There may be a little bleeding or drop of liquid at the injection site. You can press a cotton ball or gauze over the injection site until the bleeding stops.
- In case of skin contact with the medicine, wash the area that touched the medicine with water.
- If needed, cover the injection site with a small bandage.

If your prescribed dose requires more than 1 injection:

- Throw away the used prefilled syringe as described in **Step 14**.
- Repeat **Step 2 through Step 13** for the next injection using a new prefilled syringe.
- Make sure each injection is **at least 1 inch** apart from each other.
- Complete all the required injections for your prescribed dose, immediately one after another. Contact your healthcare provider if you have any questions.

After the Injection

14 Throw away (dispose of) the prefilled syringe.

- Put your used prefilled syringes in an FDA-cleared sharps disposal container right away after use.
- The Xolair prefilled syringe is a single-dose prefilled syringe and should not be used again.
- **Do not** throw away the prefilled syringes in your household trash.
- **Do not** recap the needle.

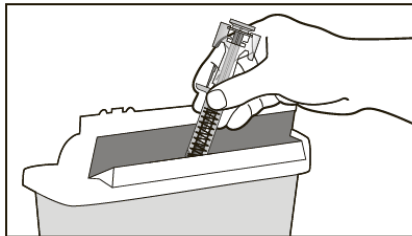

If you do not have an FDA-cleared sharps disposal container, you may use a household container that is:

- made of a heavy-duty plastic,
- can be closed with a tight-fitting, puncture-resistant lid, without sharps being able to come out,
- upright and stable during use,
- leak-resistant, and
- properly labeled to warn of hazardous waste inside the container.
- When your sharps disposal container is almost full, you will need to follow your community guidelines for the right way to dispose of your sharps disposal container. There may be state or local laws about how you should throw away used prefilled syringes. For more information about safe sharps disposal, and for specific information about sharps disposal in the state that you live in, go to the FDA's website at: <http://www.fda.gov/safesharpsdisposal>
- **Do not** dispose of your used sharps disposal container in your household trash unless your community guidelines permit this.
- **Do not** recycle your used sharps disposal container.

Manufactured by:

Genentech, Inc., A Member of the Roche Group,
1 DNA Way, South San Francisco, CA 94080-4990
U.S. License No.: 1048

Jointly marketed by:

Genentech USA, Inc., A Member of the Roche Group,
1 DNA Way, South San Francisco, CA 94080-4990
Novartis Pharmaceuticals Corporation,
One Health Plaza, East Hanover, NJ 07936-1080

Xolair® is a registered trademark of Novartis AG.
©2024 Genentech USA, Inc.

This Instructions for Use has been approved by the U.S. Food and Drug Administration.

Approved: 2/2024

Instructions for Use

Xolair® (ZOHL-air)

(omalizumab)

injection, for subcutaneous use

Autoinjector

Read this Instructions for Use before you start using Xolair autoinjector and each time you get a refill. Before you use Xolair autoinjector for the first time, make sure your healthcare provider shows you the right way to use it. Contact your healthcare provider if you have any questions.

The Xolair autoinjector is for use in people 12 years of age and older.

Do not use Xolair for the emergency treatment of any allergic reactions, including anaphylaxis, hives, or sudden breathing problems.

Xolair Autoinjector Parts

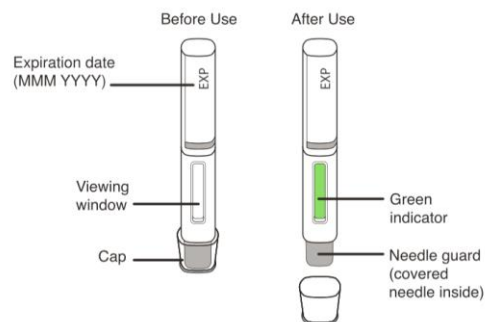

Supplies needed to give your injection

- Xolair autoinjector

The following supplies are not included in the carton:

- Alcohol swab
- Sterile cotton ball or gauze
- Small bandage
- Sharps disposal container (see **Step 15**)

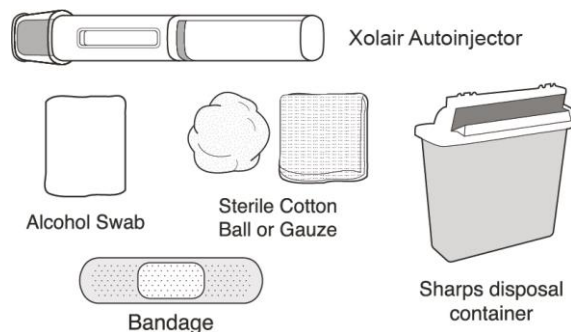











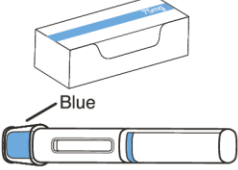
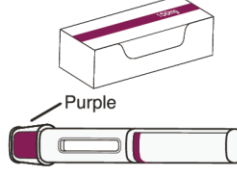
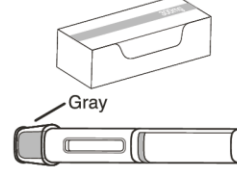



Note: You may need more than 1 Xolair autoinjector to give your prescribed dose. See the **Dosing Table** for more information. Each Xolair carton contains 1 autoinjector.

Choose the correct autoinjector or combination of autoinjectors

Xolair autoinjectors are available in 3 dose strengths (1 autoinjector in each carton). These instructions are to be used for all 3 dose strengths.

Your prescribed dose may require more than 1 injection. The **Dosing Table** below shows the combination of autoinjectors needed to give your full dose. Check the label on the Xolair carton to make sure you have received the correct autoinjector or combination of autoinjectors for your prescribed dose. If your dose requires more than 1 injection, complete all injections for your prescribed dose, immediately one after another. Contact your healthcare provider if you have any questions.

Dosing Table

	Xolair 75 mg autoinjector with a blue needle guard	Xolair 150 mg autoinjector with a purple needle guard	Xolair 300 mg autoinjector with a gray needle guard	
				
Dose	Autoinjectors recommended for dose	75 mg	150 mg	300 mg
75 mg	1 blue			
150 mg	1 purple			
225 mg	1 blue + 1 purple			
300 mg	1 gray			
375 mg	1 blue + 1 gray			
450 mg	1 purple + 1 gray			
525 mg	1 blue + 1 purple + 1 gray			
600 mg	1 gray + 1 gray			

Note: Your healthcare provider may prescribe a different combination of autoinjectors for your complete dose.

How should I store Xolair?

- Keep your unused autoinjectors in the original carton and store the carton in a refrigerator between 36°F to 46°F (2°C to 8°C).
- Before giving an injection, the carton can be removed from and placed back in the refrigerator if needed. The total combined time out of the refrigerator may not be more than 2 days. If the autoinjector is left at temperatures above 77°F (25°C), **do not** use it and throw away in a sharps disposal container.
- **Do not** remove the autoinjector from its original carton during storage.
- Keep your autoinjectors out of direct light.
- **Do not** freeze. **Do not** use if the autoinjector has been frozen.

Keep the Xolair autoinjector, sharps disposal container and all medicines out of the reach of children.

Important Information

- **Do not** use if the carton is damaged or appears to be tampered with.
- **Do not** open the carton until you are ready to inject.
- **Do not** use if the autoinjector has been damaged or appears to be tampered with.
- **Do not** take the cap off the autoinjector until you are ready to inject.
- **Do not** use if the autoinjector has been dropped on a hard surface or dropped after removing the needle cap.
- **Do not** take apart the autoinjector at any time.
- **Do not** clean or touch the needle guard.

Preparing for the Injection

1 Take the carton containing the autoinjector out of the refrigerator.

- If you need more than 1 autoinjector to deliver your prescribed dose (see **Dosing Table**), take all cartons out of the refrigerator at the same time (each carton contains 1 autoinjector). The following steps must be followed for **each** autoinjector.

2 Check the expiration date on the back of the Xolair carton.

- **Do not** use if the expiration date has passed.
- If the expiration date has passed, safely throw away the autoinjector in a sharps disposal container (see **Step 15**) and contact your healthcare provider.

Expiration date on back
(MMM YYYY)

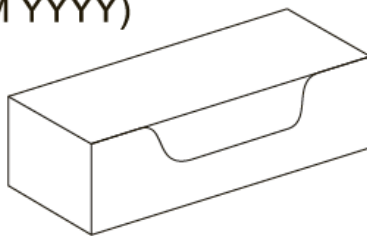

3 Allow the autoinjector to reach room temperature.

- Set aside the carton on a clean, flat surface for at least 30 to 45 minutes so the autoinjector can warm up on its own to room temperature. Leave the autoinjector in the carton to protect it from light.
- If the autoinjector does not reach room temperature, this could cause the injection to feel uncomfortable.
- **Do not** speed up the warming process using any heat sources such as warm water or a microwave.

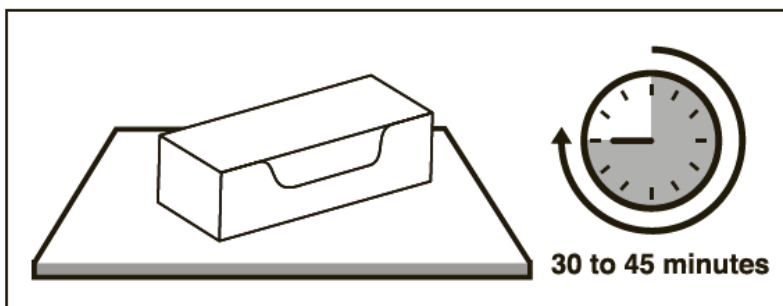

4 Open the carton.

- Wash your hands with soap and water.
- Take the autoinjector out of the carton as shown.
- **Do not** turn the carton upside down to take out the autoinjector, as this may damage the autoinjector.
- **Do not** hold the autoinjector by the cap. Make sure you hold the autoinjector by the middle as shown.
- **Do not** remove the cap until you are ready to inject.

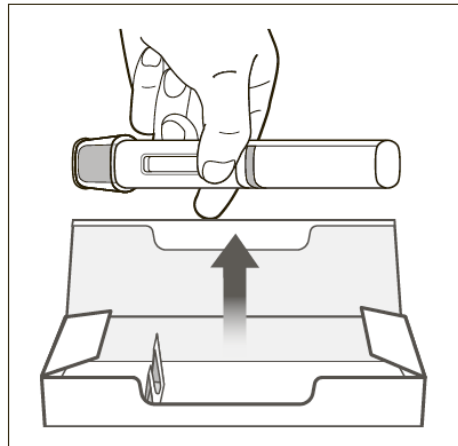

5 Check the autoinjector before use.

- Look through the viewing window of the autoinjector. The medicine in the autoinjector viewing window should be clear and colorless to pale brownish-yellow. You may see air bubbles in the medicine, which is normal.
- **Do not** use the autoinjector if the medicine contains particles, or if the medicine looks cloudy or brown.
- Check the expiration date on the autoinjector. **Do not** use the autoinjector if the expiration date has passed.
- **Do not** use the autoinjector if it appears to be damaged or tampered with.
- If the medicine does not look as described or if the expiration date has passed, safely throw away the autoinjector in a sharps disposal container (see **Step 15**) and contact your healthcare provider.

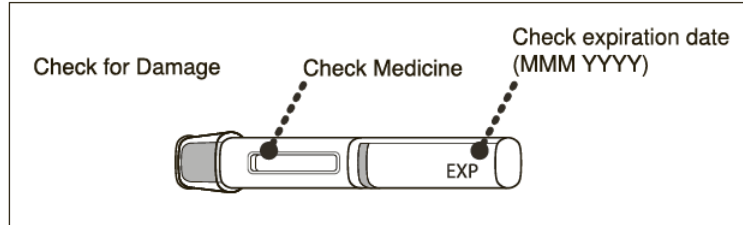

6 Choose where to inject.

- If giving yourself the injection, the injection sites are the front of your thigh or stomach area (abdomen). If a caregiver is giving the injection, the injection sites are the outer area of the upper arm, the front of the thigh or stomach area (abdomen). **Do not** try to inject yourself in the upper arm.
- **Do not** inject within the 2-inch area directly around your belly button (navel).
- **Do not** inject into moles, scars, bruises, or areas where the skin is tender, red, hard, or if there are breaks in the skin.
- **Do not** inject through clothing. The injection site should be uncovered, clean skin.
- If your prescribed dose requires more than 1 injection, make sure your injections are **at least 1 inch** apart from each other.

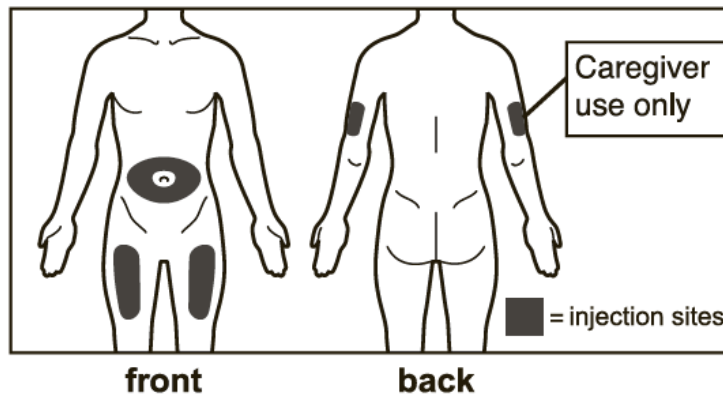

7 Clean the injection site.

- Wipe the injection site with an alcohol swab in a circular motion and let it air dry for 10 seconds.
- **Do not** fan or blow on the cleaned skin.
- **Do not** touch the injection site again before giving the injection.

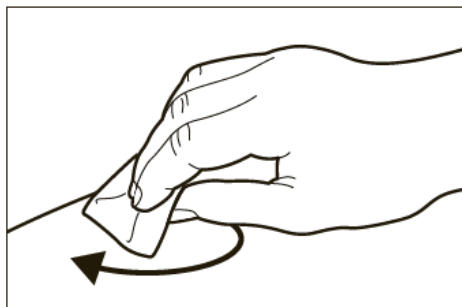

Giving the Injection

8 Remove the cap.

- Hold the autoinjector firmly with 1 hand and pull the cap straight off with your other hand as shown. **Do not** twist the cap.
- **Do not** put the cap back on the autoinjector. Throw away the cap in regular household trash.
- **Do not** clean or touch the needle guard of the device.

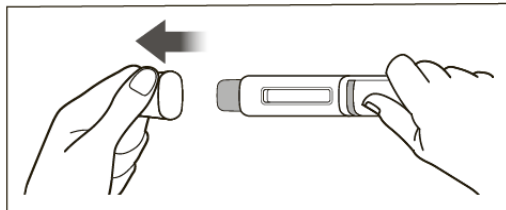

9 Position the autoinjector.

- Hold the autoinjector comfortably with the needle guard directly against the skin.
- The autoinjector should be at a 90-degree angle against the skin, as shown.

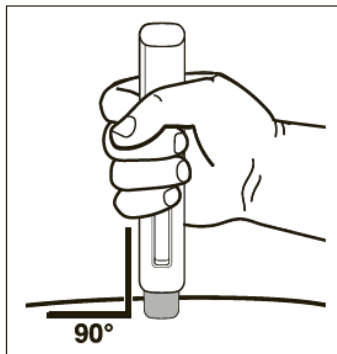

10 Start the injection.

- Press straight down and hold the autoinjector firmly against the skin. The **1st click** indicates that the injection has started.
- Hold the autoinjector tightly in place. **Do not** change the angle of injection or remove the autoinjector until the injection is completed.

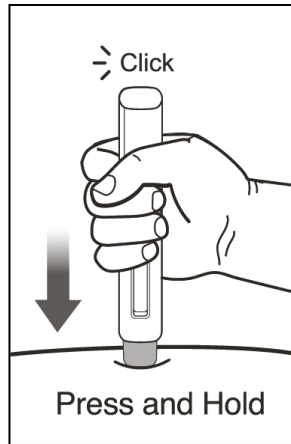

11 Monitor injection using green indicator.

- Keep holding the autoinjector against the skin. The green indicator will move within the viewing window.

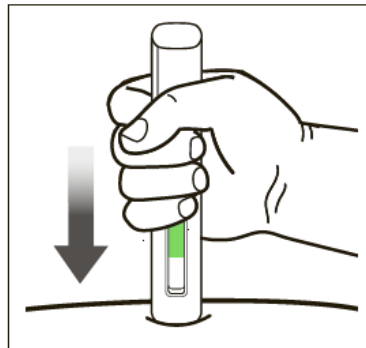

12 Complete injection.

- Listen for the **2nd click**. This indicates that the injection is **almost** complete.
- Hold the autoinjector in position until the green indicator has stopped moving and completely fills the viewing window to make sure the injection is complete.

Click

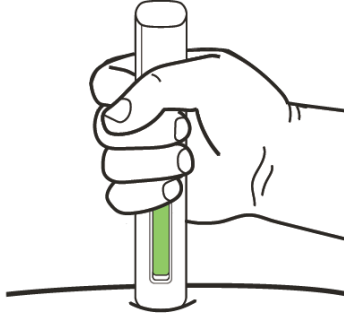

13 Remove from skin and check the green indicator.

- After the green indicator has stopped moving and has completely filled the viewing window, lift the autoinjector straight up from the skin. The needle guard will automatically extend and lock over the needle.
- If the green indicator has not completely filled the viewing window, contact your healthcare provider or pharmacist.

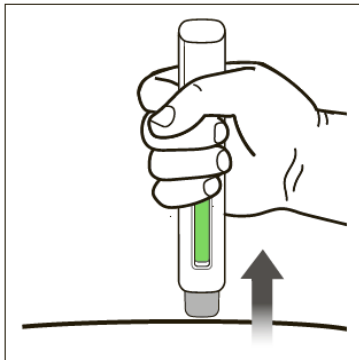

14 Care for the injection site.

- **Do not** rub the injection site.
- There may be a little bleeding or a drop of liquid at the injection site. You can press a cotton ball or gauze pad over the injection site until any bleeding stops.
- In case of skin contact with the medicine, wash the area that touched the medicine with water.
- If needed, cover the injection site with a small bandage.

If your prescribed dose requires more than 1 injection:

- Throw away the used autoinjector as described in **Step 15**.
- Repeat **Step 2 through Step 14** for the next injection using a new autoinjector.
- Make sure each injection is **at least 1 inch** apart from each other.
- Complete all the required injections for your prescribed dose, immediately one after another. Contact your healthcare provider if you have any questions.

After the Injection

15 Throw away (dispose of) autoinjector.

- Put your used autoinjectors in an FDA-cleared sharps disposal container right away after use.
- The Xolair autoinjector is a single-dose autoinjector and should not be used again.
- **Do not** throw away (dispose of) the autoinjectors in your household trash.
- **Do not** recap the autoinjector.

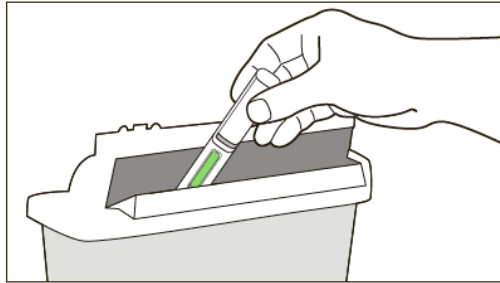

If you do not have an FDA-cleared sharps disposal container, you may use a household container that is:

- made of a heavy-duty plastic,
- can be closed with a tight-fitting, puncture-resistant lid, without sharps being able to come out,
- upright and stable during use,
- leak-resistant, and
- properly labeled to warn of hazardous waste inside the container.
- When your sharps disposal container is almost full, you will need to follow your community guidelines for the right way to dispose of your sharps disposal container. There may be state or local laws about how you should throw away used autoinjectors. For more information about safe sharps disposal, and for specific information about sharps disposal in the state that you live in, go to the FDA's website at: <http://www.fda.gov/safesharpsdisposal>
- **Do not** dispose of your used sharps disposal container in your household trash unless your community guidelines permit this.
- **Do not** recycle your used sharps disposal container.

Manufactured by:

Genentech, Inc., A Member of the Roche Group,
1 DNA Way, South San Francisco, CA 94080-4990
U.S. License No.: 1048

Jointly marketed by:

Genentech USA, Inc., A Member of the Roche Group,
1 DNA Way, South San Francisco, CA 94080-4990
Novartis Pharmaceuticals Corporation,
One Health Plaza, East Hanover, NJ 07936-1080

Xolair® is a registered trademark of Novartis AG.
©2024 Genentech USA, Inc.

This Instructions for Use has been approved by the U.S. Food and Drug Administration.

Approved: 2/2024